



Efficient Consumer Response Australasia
Getting the best out of
Logistics Labels
2015 Update

ABOUT

GS1 Australia and GS1 New Zealand

GS1 Australia and GS1 New Zealand are not-for-profit organisations and all services are provided on a cost recovery basis.

GS1 Australia and GS1 New Zealand are at the forefront of eCommerce and supply chain management initiatives, helping Australian and New Zealand businesses to adopt the world's best practice supply chain management techniques and streamline their processes to enable fast, efficient and accurate flow of information between trading partners through automation.

GS1 Australia and GS1 New Zealand offer a wide range of services to support businesses, their industry associations and trading partners to work smarter and more efficiently with the GS1 System, and improve the way they do business.

For more information about GS1 Australasia visit www1.gs1au.org or GS1 New Zealand visit www.gs1nz.org.

Efficient Consumer Response Australasia

Efficient Consumer Response (ECR) is a business concept aimed at better satisfying consumer needs, through businesses and trading partners working together.

In doing so, ECR best practices will deliver superior business results by reducing costs at all stages throughout the value chain, achieving efficiency and streamlined processes. ECR best practices can deliver improved range, consumer value, sales, service and convenience offerings. This in turn will lead to greater satisfaction of consumer needs.

ECR Australasia reflects a commitment to take costs out of the grocery supply chain and better satisfy consumer demands through the adoption of world's best practice. In an increasingly global food and grocery industry and a retail environment subject to rapid change, the future for Australian and New Zealand suppliers, retailers and wholesalers depends on increased efficiencies, reduced costs and added value for consumers.

For more information about ECR Australasia, visit www.ecraustralasia.org.au

Endorsements

ECRA endorses a national approach to logistics label standards.

ECRA, GS1 Australia and GS1 New Zealand have been pivotal in delivering aligned positioning between major retail organisations, which should assist suppliers in avoiding costly duplication of effort.

GS1 Australia has worked closely with the transport and logistics industry to align standards.



Good Food, Good Life



Acknowledgements

This report were made possible through the active support and contributions from the industry project team and their respective companies. The project was facilitated by ECR Australasia and GS1 Australia and GS1 New Zealand.

The following team members re thanked for their contribution and support.

ECRA Working Group – Order to Receipt Excellence Standing Work Group

Lynda Heeley	Woolworths Limited
Vince Vella	Simplot Australia Pty Ltd
Iain Myers	Sanitarium Health and Wellbeing Company
Mark Olson	Primo Smallgoods
Sean Carroll	Primo Smallgoods
Mandeep Sodhi	Nestle Australia Ltd
Michael Haire	Metcash Food & Grocery
Adam Wade	Lion Pty Ltd
Abby Phillips	Kimberly-Clark Australia Pty Ltd
Mario Carniato	Kimberly-Clark ANZ
Hugo Butterfield	Coles
Matt Lowe	Coles
Carlee McGowan	Coca-Cola Amatil Ltd
Malay Shah	Cerebos (Aust) Ltd

GS1 Secretariat

Andrew Steele, GS1 Australia
Craig Russell, GS1 New Zealand

ECRA Secretariat

Samantha Blake, AFGC
John Cawley, AFGC

Disclaimer

Every possible effort has been made to ensure that the information and specifications in this document are correct, however GS1 Australia, GS1 New Zealand and Efficient Consumer Response Australasia (ECRA) expressly disclaim liability for any errors. In addition, no warranty or representation is made that this document will not require modification due to developments in technology or changes or additions to the GS1 system.

Executive Summary

The following information contains guidelines and general information on how to create and apply good quality logistic (pallet) labels as per the standard requirements of the Australian Grocery and Liquor Industry.

As the Australian Grocery and Liquor Industry adopts the key principles of ECR there is increased demand for high quality data capture at all points in the supply chain. The industry has been numbering and barcoding trade items for a number of years, including logistic unit labeling. In 2010 the industry launched a range of materials including **Getting the best out of Logistics Labels** toolkit to assist in driving consistent adoption on standards for pallet labels across the industry.

The toolkit, first launched in 2010, was the result of poor results from an industry wide audit of pallet labels and SSCC's at retail distribution centres (DC's). The audit detailed a 44% error rate or non-conformance. The subsequent guide was developed by an industry work group and launched at a series of industry roadshows on the topic.

A similar survey was completed in 2014 and resulted in a 24% improvement level. However 20% of product is still failing to meet the agreed industry standards and unfortunately over the past 12 months this level has remained the same.

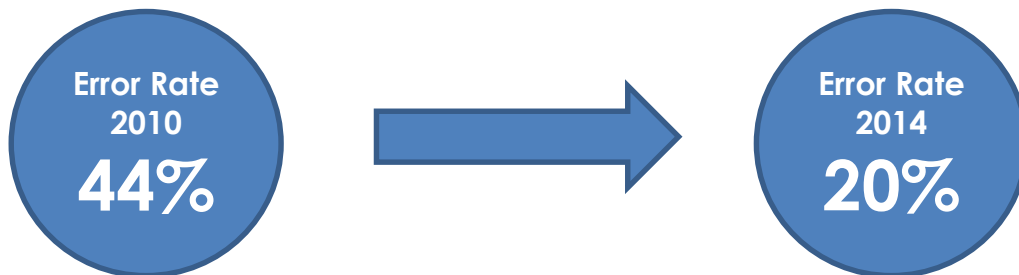

This second edition highlights not only these improvements but also the important work undertaken by GS1 Australia and Australian Logistics Council (ALC) in conjunction with the transport and logistics industry to continue to drive industry wide adoption rates.

With the migration to more and more automated scanning in warehouses, transportation and DC's, it is imperative that suppliers and their logistics providers ensure 100% scannability of all barcodes and label applications. Only when this is achieved will the industry realise mutual trading partner benefits.

Printing and applying a good quality barcode label that complies with industry standards and which is scannable by all trading partners' costs no more than printing and applying a barcode label that doesn't scan

This document and its recommendation should be read in conjunction with other GS1 technical guidelines as well as retailer specific documentation.

Contents

About	2
Endorsements	3
Acknowledgements	4
Executive Summary	5
Section 1: The Importance of Logistics (Pallet) Labels	7
Section 2: Logistics Label Requirements	9
2.1 Label Size	11
2.2 Label Format	11
2.3 Label Location	11
2.4 Label Data and Application Identifiers	11
Section 3: What is a Serial Shipping Container Code	12
Section 4: Logistic Label Location	14
Section 5: Supply Chain Considerations	17
5.1 Manufacturer/Supplier Considerations	17
5.1.1 Pallet Label Quality Standards	17
5.1.2 Visual Checklist	18
5.1.3 Audits	18
5.1.4 Training	18
5.1.5 Use of KPIs	18
5.2 Retail Consideration and Receival Processes	19
5.2.1 Woolworths Ltd and Progressive Enterprises Ltd	19
5.2.2 Metcash Trading	20
5.2.3 Coles	21
5.2.4 Foodstuffs South Island Ltd	22
5.2.5 Foodstuffs North Island Ltd	23
5.3 Logistics and Transport Providers Consideration	24
5.4 Label Hardware and Software Considerations	24
5.4.1 Printers	24
5.4.2 Print Speed	25
5.4.3 Labels	26
5.4.4 Label Application Options	26
5.4.5 Environment	26
Section 6: Common Pitfalls	27
Section 7: Further Information	28
Section 8: GS1 Services	29
8.1 Bar Code Verification	29
8.2 Training Services	29

SECTION 1: The Importance of Logistic (Pallet) Labels

The use of the logistic label incorporating the Serial Shipping Container Code (SSCC) by all parties in the supply chain, from manufacturers to transporters, distributors and retailers, is seen to be inevitable for the identification and tracking of pallets and other forms of logistic units.

The Serial Shipping Container Code (SSCC) is the GS1 Identification Key used to identify a logistic unit. This unique 18 digit identifier is comprised of an Extension Digit, a GS1 Company Prefix, a Serial Reference, and a Check Digit.

The purpose of the GS1 logistics label is to uniquely identify specific information about the pallet clearly and concisely in a standard format, to facilitate the process of moving products through the supply chain quickly and efficiently.

BENEFITS

- ✓ A unique number worldwide
- ✓ Global standards
- ✓ Applies throughout the supply chain
- ✓ Enables electronic business transactions.
- ✓ Identify contents of pallets
- ✓ Efficient stock management
- ✓ Saves costs by doing it once
- ✓ Avoids multiple label types (industry standard)
- ✓ Faster receiving, quick turnaround
- ✓ Improves data integrity
- ✓ Stock rotation based on use by date
- ✓ Pallet tracking
- ✓ SSCC works across businesses.

Numbering & Barcoding Labeling Hierarchy

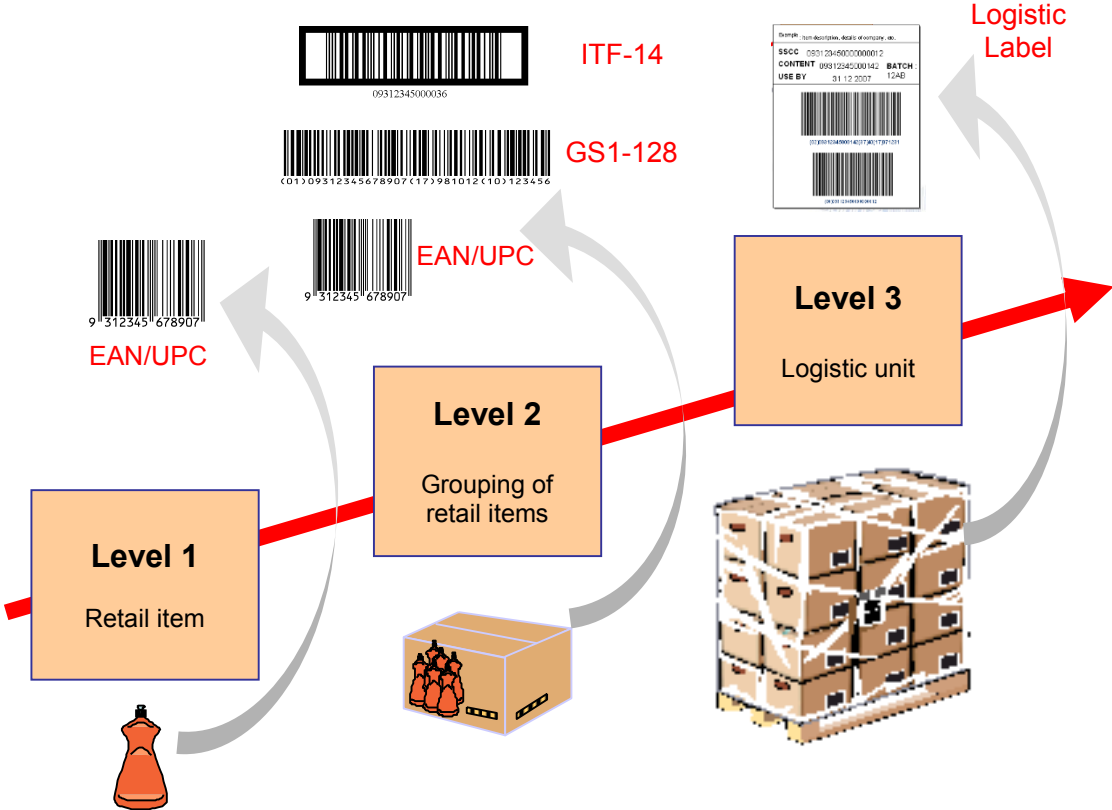

SECTION 2: Logistic Label Requirements

The GS1 Logistics Label can typically have many different formats. The SSCC is the only mandatory piece of information that must be contained on the label itself as ideally the information flow, which accompanies the physical flow of goods, is communicated between trading partners by eMessaging.

In practice, however, fully automated communication channels, which make it possible to rely exclusively on electronic files for retrieving information on the movements of goods, are not always available. In this situation there may be a requirement to add additional information to the logistics label to facilitate the process of the logistic units through the supply chain.

The purpose of the GS1 Logistics Label is to provide information about the unit to which it is fixed, clearly and concisely. The core information on the label should be represented both in barcode and human readable form. There may be other information, which is represented in human readable form only.

The major Australian Supermarket Retailers, Logistics and Transport Providers and Suppliers have agreed on a standard consistent format for the industry. The following are example of pallet labels used across the supply chain.

Australian Grocery Standard Logistic (Pallet) Label - Portrait Format
Label not to scale



- **Barcode format: GS1-128 (formerly UCC/EAN-128)**
- **AI (02)** Content (GTIN of the product on the pallet/logistic unit,
- **AI (37)** Count (Quantity)
- **AI (17)** Use By Date, Use **AI (15)** if Best Before Date
- **AI (10)** Batch Number
- This data can also be represented in multiple barcodes
- Barcode Height: 32 mm
- Magnification Factor: 25-100%
- Quiet Zone: Min 10.16 mm @ 100%
5.08 mm @ 50%
2.54 mm @ 25%

- **Barcode format: GS1-128 (formerly UCC/EAN-128)**
- **AI (00)** Serial Shipping Container Code (SSCC)
- Barcode Height: Minimum 32 mm
- Magnification Factor: 48.7-92.5%
- Quiet Zone: Minimum 9.40 mm @ 92.5%
4.95 mm @ 48.7%

2.1 Label Size

- The minimum label size is A6, 105mm x 148mm, however larger label sizes such as A5 or A4 are permitted

2.2 Label Format

- The label layout can be either portrait or landscape
- Information contained in the top barcode can be broken down into more multiple barcodes if required, in order to maintain a larger magnification (bar width)

2.3 Label Location

- Two identical labels, one placed on each fork entry side
- Label should be placed between 50mm – 100mm from the right hand vertical edge
- Label should be placed between 400mm – 800mm from the base of the pallet
- The target placement of the label (top of SSCC barcode) is 600mm from ground level.

2.4 Label Data and Application Identifiers

- SSCC number – AI (00)
 - No additional information is to be included in the SSCC (00) barcode
- GTIN of the product – AI (02)
 - The data format for AI (02) is that it has to be numeric and 14 digits in length. **Note:** that if your carton GTIN and barcode is 13 digits (e.g. a case of beer or soft drink), you need to include an additional zero at the beginning to increase it to 14 digits
- Quantity of trade units on the pallet - AI (37)
- Date Information YMMDD – Mandatory if this information is on consumer unit
 - Use By Date – AI (17)
 - Best Before Date – AI (15)
 - Packed on Date – AI (13)
- Batch Number, if on consumer unit – AI (10)
- Total Net Weight – Mandatory if product is variable weight (excluding wooden pallet weight – AI (310n) where n = number of decimal places e.g. 3102 = x.xxkg, 3101 = xx.xkg, 3100 = xxxkg)

SECTION 3: What is a Serial Shipping Container Code

The Serial Shipping Container Code (SSCC) is a reference number or license plate used to uniquely identify logistics units (pallets). The SSCC acts as a “reference key” which can be stored in a computer system to which information can be added and shared amongst trading partners as the logistics unit moves throughout the supply chain. This unique “license plate” provides the opportunity to track and trace logistic units in the supply chain.

Scanning the SSCC marked on each logistic unit allows the physical movement of units to be individually tracked and traced by providing an information flow. It also opens up the opportunity to implement a wide range of applications such as cross docking, shipment routing, automated receiving etc.

The SSCC is used to uniquely identify goods on the way from sender to final recipient, and can be used by all participants in the transport and distribution chain.

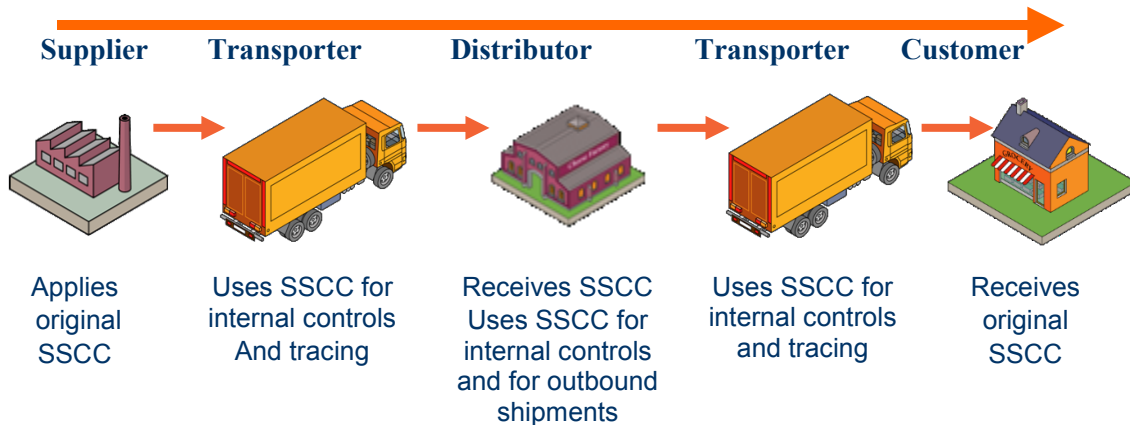

The SSCC is a unique, non-significant, eighteen-digit number which is **assigned by the company constructing the logistic unit**. It remains the same for the life of the logistic unit. The SSCC is encoded in a GS1-128 (formerly UCC/EAN-128) Bar Code and is represented by the Application Identifier (AI) 00. For more information on Application Identifiers refer to:

GS1 Australia Numbering & Barcoding User Manual at:
http://www.gs1au.org/information_library/user_manuals.asp

GS1 New Zealand's Services Documents & Tools Library
<http://www.gs1nz.org/resources/services-document-and-tool-library/>

An individual SSCC number must not be reallocated within one year of the shipment date from the SSCC assignor to a trading partner.

Figure 3: Structure of the SSCC

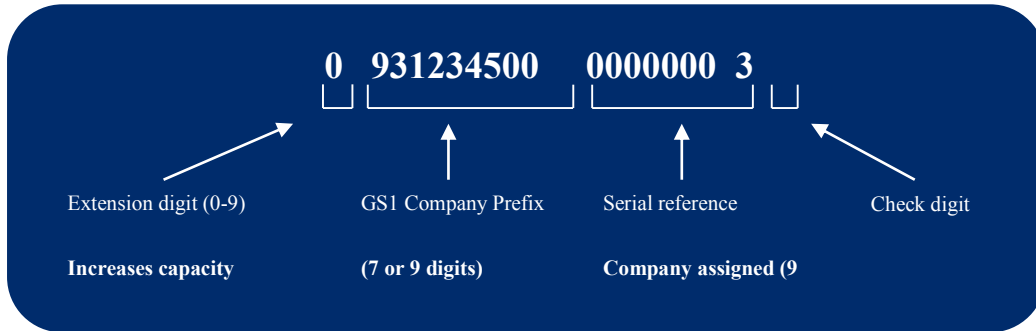

Application Identifier (00):	Used in the GS1-128 Bar Code to identify that the data following is an eighteen-digit Serial Shipping Container Code (SSCC)
Extension Digit:	A digit (0-9) used to increase the capacity of the Serial Reference within the SSCC. The company that constructs the SSCC assigns the extension digit to the logistic unit.
GS1 Company Prefix:	The GS1 Company Prefix is allocated by GS1 Member Organisations. GS1 typically allocates a 7-9 digit GS1 Company Prefixes. It makes the SSCC unique worldwide but does not identify the country of origin of the unit.
Serial Reference:	A Serial Reference usually comprises seven digits (nine digits if the GS1 Company Prefix is seven digits) and uniquely identifies each transport package or logistic unit. The method used to allocate a Serial Reference is at the discretion of the company coding the package.
Check Digit:	The last digit is mathematically calculated Check Digit that ensures the whole number is correct. A Check Digit calculator program which will automatically calculate the Check Digit can be obtained from the GS1 Australia web site at www.gs1au.org .

Combined Transport & Grocery Standard

GS1 Australia and Australian Logistics Council are working in partnership with a group of industry experts to develop a combined transport and grocery logistics label.

Working on a fully integrated approach specifically for the transport and grocery sector will deliver real benefits to the industry.

For more information on this project contact GS1 Australia or Australian Logistics Council.

SECTION 4: Logistic Label Location

Australian Grocery and Liquor industry requirements is a GS1 Logistics Label to be placed on each fork entry side.

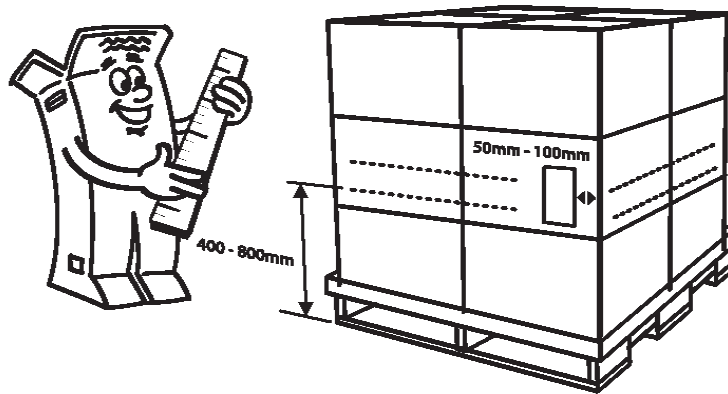

If the pallet height does not permit the pallet labels to be at least 400mm from the ground, then the pallet labels should be placed as high as possible on the right hand side on each of the fork entry sides of the pallet. (Refer to the figure below).

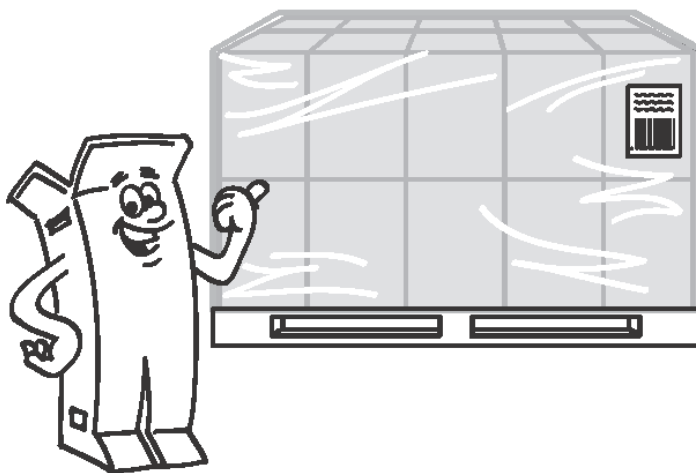

If the pallet needs to be stretch wrapped for stability, the pallet labels must be applied to the **outside** of the stretch wrap as shown above in order to achieve optimum scan rates.

Where there is only one layer high of the trade unit on a pallet and the trade unit height is less than the height of the pallet labels. Please ensure that the bar codes of the labels are on the vertical face of the trade unit with the human readable portion of the labels folded over onto the horizontal surface of the trade unit.

Multiple Products on a single pallet layer

For Woolworths and Progressive, a maximum of 4 different line items can be delivered on one pallet as long as the combined total of those cartons does not exceed 1 layer (footprint). Metcash requirements are 1 product per pallet or if not one product per pallet each product must have its own SSCC label.

Multiple Stacked Pallets – Option 1 of 2

Deliveries can be made with multiple stacked pallets which are stretch wrapped together in “one footprint”. Each individual pallet will need to have its own pallet label applied **directly on the carton** and **underneath** the stretch wrap. One pallet label on each of the fork entry sides of the pallet, so when the stretch wrap is cut away to separate the pallets, the pallet labels are not lost, as shown below

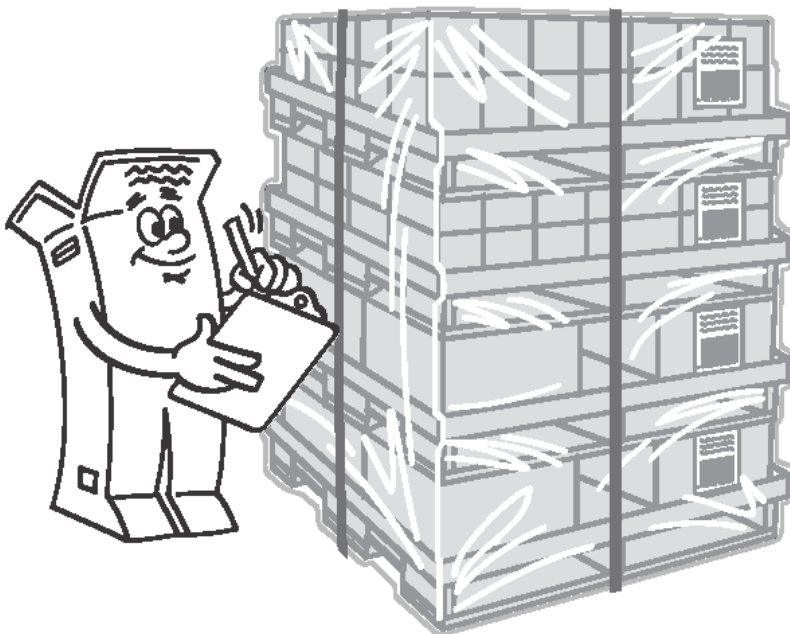

Multiple Stacked Pallets - OPTION 2 OF 2 -Pallets Wrapped Individually

Where each line item pallet is stretch wrapped individually, pallet labels will need to be affixed to the **outside** of the stretch wrap on both of the fork entry sides of the pallet, as shown below



SECTION 5: Supply Chain Considerations

5.1 Manufacturer/Supplier Considerations

5.1.1 Pallet Label Quality Standards

Controlling label quality variation requires an integrated quality process incorporating people, processes, procedures and equipment.

Typically there are two options for the application of the pallet label:

- At the point of manufacture, or
- At the point of dispatch

The decision on when to apply the pallet label is dependent on individual organisations practices, including manufacturing, warehousing, order assembly or third party service providers.

The SSCC label standards should be incorporated into internal standards and available (electronically) to all factories and warehouses. The same standards are communicated to third party providers both at contract time and by the use of training packages, if necessary. Visual aids are encouraged in factories, warehouses etc. to impart SSCC label standards, especially positioning of the labels.

With many automated and manual labeling systems check scanning controls can be purchased as part of the system, providing a level of automated barcode quality checking and control. These systems incorporate a check scanner at the front of the label printer so that as each label is printed the barcode is scanned to check quality. If a fail to read occurs the printer can print void on the erroneous label and re-print. After multiple failures i.e. 2 or 3, the unit will stop and raise an alarm.

Considerations

- Automate the data sources to simplify printing and reduce the need for data entry.
- Label design tested and sent to GS1 testing service for its verification report
- Document processes
- Train staff to visually
 - check the pallet label and position applied
 - scan label barcodes to ensure readability

Incorporate checks for

- ✓ Correct Barcode symbology (GS1-128)
- ✓ Label placement
- ✓ Label verification
- ✓ Label Defects

5.1.2 Visual Checklist

Does the data encoded in the pallet label barcodes match the product on the pallet?

- GTIN
- Batch number (if applicable)
- Quantity
- Date code information, e.g. best before or use by date

The pallet labels applied to the pallet must contain the same SSCC number. Pallet labels should not be placed over two separate cartons. Pallet labels should be placed on the outside of the stretch-wrap. Determine if any white lines running vertically through the black lines of the barcode that may hinder the barcode from scanning are evident.

5.1.3 Audits

It is recommended to perform a compliance audit of the labels coming from each factory, warehouse and third party provider every quarter. Results should be reported back as percentage compliance and the issues found are highlighted, together with photos, if necessary.

5.1.4. Training

It is imperative that anyone that is required to print or apply pallet labels understand the industry requirements. Training and documentation is widely available. Refer to section 10.

5.1.5 Use of KPIs

Establish performance metrics as part of the pallet quality checking procedures. This could be plotted graphically by warehouse upon feedback from trading partners.

The data should be circulated to all factories and warehouses including third party logistics providers, each week with any relevant comments. Provide all of the raw data obtained to help finding solutions to particular issues. Include the overall trend of performance for the last twelve months

Communicate progress to factory and warehouse managers at regular operations meetings to ensure the focus is maintained on the importance of achieving this and other key supply chain standards.

5.2 Retail Consideration and Receival Processes

5.2.1 Woolworths Ltd and Progressive Enterprises Ltd



You wouldn't drive a car without license plates on the front and back. Woolworths and Progressive want to drive pallets more efficiently through our joint supply chain by using industry standard pallet labels on the front and back, containing the unique SSCC number and other information about the contents of the pallet. Using Industry Standard pallet labels are a way for Woolworths, Progressive and their trading partners to work together to lower end-to-end supply chain costs.

In January 2000, all Woolworths Purchase Orders (PO) delivered into Minchinbury (NSW) and Hume (VIC) ambient Distribution Centres (DC) required an identical pallet label on each fork entry side of a pallet. Since 1 January 2005, all Woolworths PO delivered to any Woolworths DC and any Woolworths 3PL DC require a pallet label on each fork lift entry side of a pallet (i.e. 2 identical pallet labels per pallet).

When logistic label requirements are not met or adhered to, the direct or in-direct costs can be substantial. A receiving process that should take a few seconds per pallet suddenly takes a few minutes as generic labels need to be printed and applied onsite and all pallet details re-keyed manually by a staff member. One issue in applying generic labels is the loss of traceability of the SSCC number, which can have severe cost impacts if a product recall occurs in the future.

These problems and delays very soon add up and hinder our ability to turn your vehicle around in the shortest possible time. The sooner we can verify and process your delivery, the sooner we can have your trucks turned around and your drivers back on the road. This is not only important in the context of cost reduction but is vital to achieving our shared goals and obligations with respect to Chain-of-Responsibility and driver fatigue management.

- On arrival, a Woolworths Receiver will key in the Purchase Order numbers from the paperwork provided by the truck driver
- The Woolworths Receiver will then proceed to the first pallet on the load. The checker will scan all of the barcodes on the logistic label, then one of the barcodes on the carton.
- The RF scanners will transmit the information back to the Distribution Centre's Warehouse Management System (WMS). The WMS will then verify the scanned information against the Purchase Orders, cross referencing delivered quantities against ordered quantities and checking any best before dates against the minimum and maximum ranges loaded into the system.
- The WMS confirms that the product referenced in the logistic label corresponds to the barcode on the trade unit. If no problems are encountered, the checker moves onto the next pallet and goes onto receive the remainder of the vehicle at which point forklifts begin to unload the vehicle to either a staging lane or in-feed point.

- In **non-automated DCs** forklift drivers will pick up the pallet, scan the logistics label again and will be electronically prompted by the WMS with a location to take the pallet to.
- In **automated DCs** forklift drivers will take the pallet to an in-feed point. Once placed on the conveyor system the pallet will pass by the fixed head scanners which check both fork entry sides of the pallet for a valid ID. If the logistic label can be scanned successfully and the pallet identified, the system manages the storage and retrieval of the pallet automatically from this point.
- If the pallet cannot be identified the system will reject it from the in-feed process and it will be re-worked and re-labelled by a staff member before subsequent in-feed attempts.

5.2.2 Metcash Trading



To achieve a cost effective flow of goods, packaging and barcode specifications must consider the needs of manufacturing, distribution and retail operations. The objective is to have scannable barcodes and accurate logistics master data to support cost effective movement and protection of product through the supply chain minimising the safety risk imposed on those that handle the goods.

A number of barcode requirements, such as trade unit and logistics labels are “Core Competencies” to conducting business with Metcash Trading Limited today. Compliance with these requirements is vital to ensure products move through our supply network in a safe and cost effective manner to our retail customers and also allows for integration with Metcash's eTrade (EDI) procurement process.

- On arrival, a Metcash receiving checker will key the purchase order number or appointment number (for a multiple PO truck) into the RF receiving unit.
- The receiver will then proceed to the first pallet on the truck and scan all of the barcodes on the pallet label.
- The RF scanner will send the information back to the WMS that will verify the quantities on that pallet against the order quantity on the ASN for full eTrade receiving or the PO for non-eTrade receiving. The WMS also verifies the Ti Hi information is correct and checks that the date code on the item is suitable against the minimum and maximum dates set in the WMS.
- If the pallet is accepted then the receiver moves along to the next pallet and repeats the process. If the pallet is not accepted the checker will conduct an investigation to identify the issue and will re label with a generic label if required.
- Once all pallets are received, the checker will confirm the total quantity against the invoiced quantity and then close the load ready for the pallets to be put away by forklifts using RF scanners. The WMS determines the final location in the warehouse during the receipt process.

Business-to-business e-Commerce ("B2B") is an essential part of the Coles Replenishment and Supply Chain operation, and fundamental to the way that we exchange information and interact with our supply partners.

As a key component of the wider B2B framework, SSCC labelling (for pallets and logistic units) continues to be essential to our ability to trade effectively, enabling the efficient, accurate processing of pallets in high-volume DC environments.

Whether paired with full B2B implementation (ie. linked with ASNs and an integrated ERP system) or created and managed independently, SSCC pallet/logistics units labelling allow us to replace manual, repetitive, time-consuming and error-prone tasks with fast, accurate and traceable electronic processes, delivering an optimised E2E path that benefits suppliers, Coles and - most importantly - our shared customers.

We actively encourage suppliers to develop SSCC Pallet/Logistic Unit capability and to label pallets as per our Supplier Delivery Standards:

<https://www.supplierportal.coles.com.au/csp/wps/portal/web/SupplyChain>

Our DC process:

- On delivery into any receiving location, merchandise is electronically scan receipted utilising a combination of the SSCC label, GTIN barcode, Invoice/Consignment Note, visual inspection, WMS validation and ASN validation as appropriate.
- (Depending upon specific operational requirements, the site may 'Subject to Check' the load, allowing the truck to depart before receipt process has been completed. This 'Subject to Check' process includes unloading and verifying the number of Pallets present along with a check of stock).
- Where applicable, all ASNs must include all of the relevant details about the load (SSCC/LPN/License plate and SKU information) and have been transmitted to Coles before the goods arrive at the GHPL DC in order for it to be validated (and rectified if necessary).
- The merchandise is electronically scanned and receipted via the WMS, linking pallet SSCC's with the ASN provided for the load.
- Once the load has been checked, details are finalised triggering the process to update inventory on site and process payment for the goods.

5.2.4 Foodstuffs South Island Ltd



The wider application of SSCC barcodes in the supply chain further enhances Foodstuffs policies on barcode compliance and our desire to provide end-to-end electronic business capability.

Our objective is to have accurate working barcodes that when combined with accurate master data, provides the most productive and cost effective movement of goods through our distribution centres.

The SSCC process is as follows:

Inward Goods

- Upon purchase order (P/O) delivery, a FSSI goods receipt checker validates the purchase order number into our Warehouse Management System (WMS) and enters the number of pallets and lifts that are to be processed.
- WMS then allows that purchase order to be goods receipted against and also accesses the supplier's advanced shipping notice (ASN), if that vendor is required to supply more detailed information. The ASN must be transmitted to FSSI before the goods arrive at the DC.
- If the supplying vendor supplies an ASN and is a 'trusted partner', then the P/O is automatically updated and closed for further processing and the pallets are updated into WMS for pickface and storage allocation.
- If the supplying vendor is not a 'trusted partner' (even if an ASN is provided), the goods receipt checker then scans each pallet that has a SSCC barcode.
- The WMS system then verifies the article and quantities on that pallet against the order quantity on the ASN or P/O. WMS also verifies other key data such as the pallet configuration and weight. The packaging or expiry date details are validated against our defined acceptable limits.
- If the pallet receipt fails on any checks, the Inward Goods Supervisors are notified and will investigate the issue and resolve based on defined processes.
- If the pallet is accepted then the goods receipt checker continues on to receipt the next pallet and the process is repeated.
- As pallets are completed, WMS allocates a storage or pickface location for the pallet to be taken to and the pallet is now 'awaiting putaway'.
- Once all pallets on the P/O are received and all discrepancies are resolved, the Inward Goods Administration team will close the P/O.

Forklift Operations

- Once a pallet containing a SSCC is processed through Inward Goods and it is Putaway into a storage location, that pallet becomes available for pickface replenishment or a pallet pick to our customers.
- WMS links the SSCC barcode/pallet and location for full traceability throughout the DC and its processes.
- If the pallet is replenished to the pickface, the SSCC pallet is scanned during this process. It remains 'alive' until the full quantity on the pallet is placed into the pickface.
- If the pallet is selected as a pallet pick, then the SSCC identifier is finished in WMS when that forklift task is completed.

Despatch Operations

- When a customer order has been picked and is ready for delivery loading every pallet is checked to ensure an outbound 'despatch label' is applied to the pallet. This label contains a SSCC barcode that can be used in our loading audit process and also in the goods receipt process at our major banner group retail stores. We also supply an ASN to these stores.

Retail Stores

- The retail stores that operate our SAP inventory system can scan the SSCC despatch label and retrieve the ASN data that contains all articles and quantities supplied on the delivery.
- This provides the store with the opportunity to perform audit checks if they desire, or to automatically goods receipt the delivery into their inventory

5.2.5 Foodstuffs North Island Ltd



Foodstuffs North Island does not currently have the ability to process an SSCC label if one is attached to a delivery arriving at one of our Distribution Centres. We are currently investigating upgrading our Warehouse Management System. A requirement of any new upgrade would be the ability to manage SSCC labels attached to supplier deliveries.

5.3 Logistics and Transport Providers Consideration

Many suppliers today use logistics and transport service providers to fulfill some or all of their supply chain requirements. Third party logistics providers typically specialise in integrated operation, warehousing and transportation services that can be scaled and customised to customer's needs.

Questions to consider in relation to logistics and transport services providers, regarding logistics unit labeling would include:

- What role/service are they providing
- Are they applying labels
- Have you incorporated them into your logistic unit labeling requirements
- What Label application and quality control process do they have in place
- Are they scanning any part of the label prior to dispatching goods
- What is their label printer cleaning and maintenance process

5.4 Label Hardware and Software Considerations

5.4.1 Printers

Today both desk top and automated print & apply labeling systems are available. The most common bar code label print and apply methods are direct thermal and thermal transfer.

Direct Thermal: Direct thermal printers contain a thermal print head that applies heat energy to a specially coated facestock that turns black when heated to create the required images. Direct thermal saves money by not requiring the use of an inking ribbon. However, the coated facestock is more expensive than non-thermally coated facestocks and is very sensitive to temperature, light, water, chemicals and hard use. The life expectancy of direct thermal labels is usually less than one year. Direct thermal labels perform best for short term or indoor uses such as products with short shelf lives, shipping or indoor inventory control. There are two types of label face stocks; Thermal Eco and Thermal Top.

Thermal Eco is only advisable for use in short term distribution where goods are dry. They shouldn't be used in cool or freezer conditions as the material will absorb moisture and turn black, thereby obliterating print and barcodes. Thermal Eco has a sensitive surface and any rubbing with other products will generally result in labels having a smudged or scratched surface.

Thermal Top is far more durable than Thermal Eco and is relatively impervious to moisture. It has a top coating to protect the thermal coating from being defaced by rubbing or scratching. Both materials are suitable Thermal/Thermal Transfer Printers Zebra, Intermec, Toshiba, Tec, Datamax and others. Print-head life is diminished by approximately 50% using thermal label stock over Thermal Transfer label stock.

Thermal Transfer: Thermal transfer printing is the most widely used method for in-house bar code label printing. A thermal print head is used to generate heat energy that in turn transfers the ink from a ribbon onto the label facestock, creating the required images. This method improves upon direct thermal printing in several ways.

- A wide variety of both paper and synthetic facestock materials may be used with black ribbons
- Print quality is very high; the image is long lasting and durable.
- Bar codes can easily be read by both infrared and visible light reading devices.
- Double the print-head life compared to thermal label stock

A wide variety of thermal transfer ribbons are available and it is very important to match your ribbon selection to your application.

There are three basic formulations of thermal transfer ribbons that are:

- "Wax-based ribbons" are low in cost and suitable for most applications. Label images may be scratched in use or smear if the temperature is too high (i.e. over 50°Celsius)
- "Wax-resin ribbons" produce label images with higher durability than wax-based ribbons but are lower cost than pure resin based ribbons. It is the most popular ribbon as it can be used on a wide range of materials that include PE and PP materials.
- "Resin-based ribbons" produce label images that are much more resistant to wear and extreme conditions. Some resin inks used on certain facestocks can withstand temperatures over 1000 degrees. However, resin-based ribbons tend to be rather expensive.

Whichever ribbon or ribbons you use, be sure your media supplier has assured you that the ribbon:

- a) Has a combination of tensile strength and smooth surface that will allow for high-speed printing but will not tear, stick or slip during the actual label printing operation.
- b) The ink is of the proper type and formulation and can be applied uniformly to the selected facestock and that it binds well.

One important consideration when using Thermal transfer for producing barcode labels is the possibility of ribbon wrinkle which can result in unreadable barcodes. The label printer must be aligned correctly to ensure even tracking of ribbon.

5.4.2 Print Speed

You may need from 2 to 12 inches per second (IPS) print speed for your label generation requirements, however even more important is label throughput, measured in labels per minute. Make sure that your printer of choice can produce the minimum number of high quality labels to meet your requirements. Different printers have "mean time before failure" (MTBF) specifications. Also check print-head warranties and whether on-site servicing is available.

Maintenance agreements should be included as part of set-up and training. It is also essential that all staff are aware of the necessary daily cleaning requirements of these units. This should be included in their routine maintenance procedures. Most

printers come with a 12 month warranty but have options for extended warranties. Print-heads generally are not in a warranty agreement.

5.4.3 Labels

It is important to consult a reputable label supplier to give you direction as to the best label face stock and adhesive to be used. The choice of label face stock will revolve around whether a direct thermal or thermal transfer method of printing is used. Other issues to come into play are the intended lifespan of the label and whether the label is likely to come into contact with moisture.

Thermal label stocks are used for short term labeling up to 6 months which the longevity is dependent on the environment. This material is not UV stable and will deteriorate in direct sunlight within days.

In terms of adhesive choice, consideration must be given to the substrate the label is being applied to i.e. stretch wrap or cardboard. Knowledge of the temperature at the time of application, and during service, is vital. In chilled/frozen environments as you need to get a label facestock that has a coating that does not absorb moisture. This is particularly important if it is anticipated that the label will need to remain on the pallet for a couple of months. For instance, a specific freezer grade adhesive may be necessary if the label is being applied to pre-frozen items

5.4.4 Label Application Options

Labels can either be hand applied in conjunction with a desk top thermal printer or applied automatically in an online environment.

5.4.5 Environment

Attention must be paid to the environment in which the hardware and labels are stored and used. Ideally the printing and application of the labels should be conducted in a clean environment and at temperatures that are neither extremely cold nor hot. Issues such as dust can impact upon printer performance whilst temperature extremes will prematurely degrade the labels.

SECTION 6: Common Pitfalls

It is imperative that suppliers and logistics providers ensure 100% scannability of all barcodes.

There are many reasons as to why pallet labels may not meet industry requirements, here are some examples

- Label position incorrect refer to section 6
- No pallet label applied
- Multiple or mismatch SSCC on the same pallet refer to section 5
- Duplicated SSCCs (refer to section 5 reuse of SSCC's
- Damaged label such as creases and folds.
- Will not scan due to incorrect barcode symbology or poor print quality
- Label applied underneath stretch wrap
- Pallet label applied to only one side of the pallet
- Product information applied in the barcode does not match the product on the pallet
- Pallet label barcodes not scanning
 - Ribbon wrinkle with thermal transfer application
 - Print-head element failure leading to a line through a black bar (split bar) within the barcode
 - Poor print quality – faint print due to the label print-head heat being too low or the print speed too high
 - Poor print quality – bleeding print due to the label printer print-head heat being too high with the print speed too low
- Handwritten changes are not reflected in the barcode and are therefore not permitted on pallet labels
- Label applied over carton joins/seams causing tearing

SECTION 7: Further Information.

Contact GS1 for more information on how GS1 can support industry in meeting requirements.

GS1 Global ratified the following logistics label guidelines in 2015:

http://www.gs1.org/docs/tl/GS1_Logistic_Label_Guideline.pdf

- **GS1 Australia**

National Number: 1300 366 033

Contact Email: gs1aust@gs1au.org

Website: <http://www.gs1au.org>

GS1 Australia solution provider directory <http://www.gs1au.org/membership/spd/>

For further information on Application Identifiers including their format, refer to GS1 Australia's Numbering and Barcoding User Manual:

http://www.gs1au.org/information_library/user_manuals.asp

- **GS1 New Zealand**

Contact number: 0800 10 23 56

Contact Email: info@gs1nz.org

Website: <http://www.gs1nz.org/>

GS1 New Zealand solution provider directory

<http://www.gs1nz.org/services/solution-providers/>

For further information on Application Identifiers including their format, refer to GS1 New Zealand's Services Documents & Tools Library

<http://www.gs1nz.org/resources/services-document-and-tool-library/>

- **Woolworths and Progressive**

Woolworths Ambient, Liquor, Chilled and Frozen DC Barcode Label:

<http://www.wowlink.com.au/TopicCentre/SupplyChain/PackagingBarcodes/Specifications>

- **Metcash**

Metcash Packaging, Barcode & Logistics Specifications:

<http://www.metcash.com/supplier-information/logistics-cross-dock/metcashpackagingbarcodeandlogisticsspecificationsv12/>

- **Coles**

Coles B2B Logistic Labelling Standards:

<http://www.supplier.coles.com.au/eCommerce/implementing-b2b/rules-standards.aspx>

- **Foodstuffs NZ**

For further information contact Foodstuffs at <http://www.foodstuffs.co.nz/>

- **Efficient Consumer Response Australasia**

<http://www.ecraustralasia.org.au/>

SECTION 8: GS1 Services

8.1 Bar Code Verification

GS1 Australia and GS1 New Zealand offers a bar code verification service to all members. Bar codes are tested for print quality against ISO standards to ensure they will be read easily through the supply chain. We also test the validity of the number encoded and ensure it is unique to this product and within the brand owner's available allocation.

A full Bar Code Verification Report is issued for each test that confirms compliance and makes educational suggestions for improvement where applicable.

For further information on this service visit:

GS1 Australia - http://www.gs1au.org/services/barcode_testing/

GS1 New Zealand - <http://www.gs1nz.org/services/barcodes/verifying-bar-code/>

8.2 Training Services

Different training modes make GS1 learning convenient even for the busiest of schedules. An array of education options and training sessions allows members to get the supply chain management education you need, regardless of where you live or when you are available.

For further information on training options visit:

GS1 Australia - http://www.gs1au.org/services/education_and_training/

GS1 New Zealand - <http://www.gs1nz.org/news-and-events/>

